

## Description

Single pole thermal circuit breaker in miniaturised design. A positively trip-free snap action mechanism ensures a reliable switching behaviour. They meet the requirements of the circuit breaker standard EN 60934 (IEC 60934): R-Type, TO. For higher current ratings in a similar design please see our 1140 version. The 106 version combined with a C14 appliance inlet is also available as a ready-for-use power entry module (optionally with or without line filter).

## Typical applications

Hand tools, domestic appliances, overcurrent protection of PCB conductor paths, marine vehicles, mobile homes

## Approvals

Approval authority	Standard	Rated voltage	Current rating range
VDE	EN 60934	AC 240 V DC 48 V	0.05 A ... 8 A 0.05 A ... 10 A
UL	UL1077	AC 250 V DC 48 V	0.05 A...10 A 0.05 A...10 A
CSA	C22.2 No 235	AC 250 V DC 48 V	0.05 A...10 A 0.05 A...10 A
CQC	GB 17701	AC 240 V DC 48 V	0.05 A...8 A 0.05 A...10 A

## Compliance



## Preferred types

Preferred types	Preferred ratings (A)											
	0.5	0.8	1	1.2	1.5	2	3	4	5	6	8	10
106-P10-	x	x	x	x	x	x	x	x	x	x	x	x
106-P30-	x	x	x	x	x	x	x	x	x	x	x	x



## Technical data

For detailed technical information please see [www.e-t-a.de/ti\\_en](http://www.e-t-a.de/ti_en)

Rated voltage	AC 240 V, DC 48 V		
Current rating range	0.05 ... 10 A		
Typical life	<b>0.05 ... 5 A</b>	1,000 cycles at 2 x I <sub>N</sub> , inductive DC 28 V; 3,000 cycles at 2 x I <sub>N</sub> , inductive	
	<b>6 ... 8 A 10 A</b>	500 cycles at 2 x I <sub>N</sub> , inductive 50 cycles at 2 x I <sub>N</sub> , inductive	
Ambient temperature	-20 ... 60 °C (T 60)		
Insulation coordination (IEC 60664)	2.5 kV /2 reinforced insulation at operating area		
Dielectric strength	<b>Actuating area</b> Test voltage AC 3,000 V		
Insulation resistance	> 100 MΩ (DC 500 V)		
Interrupting capacity I <sub>cn</sub>	0.05 ... 8 A 0.05 ... 10 A	6 x I <sub>N</sub> (AC) 6 x I <sub>N</sub> (DC)	
Rupture capacity (UL 1077)	<b>I<sub>N</sub></b>	<b>U<sub>N</sub></b>	<b>S.C.</b>
	0.05 ... 10 A	AC 250 V	2000 A, C1
	0.05 ... 10 A	DC 48 V	200 A, C1
Degree of protection (IEC 60529)	Operating area IP40 IP00 terminal area		
Vibration	10 g (57-500 Hz), ± 0.76 mm (10-57 Hz), Test to IEC 60068-2-6, test Fc 10 frequency cycles/axis		
Shock resistance	25 g (11 ms) Test to IEC 60068-2-27, test Ea		
Corrosion	96 hours at 5 % salt mist, Test to IEC 60068-2-11, test Ka		
Humidity	240 hrs 95 % RH, test acc. to IEC 60068-2-78, Test Cab		
Mass	approx. 10 g		

## Ordering number code

### Type No.

- 104** PCB mounting type (-PR) or mounting type (-P30/-P10)
- 105** Snap-in panel mounting
- 106** Threadneck mounting with screw-in hexagonal and plastic knurled nut<sup>(1)</sup>
- 106-M2** Threadneck mounting with large lug and screw-in hexagonal and plastic knurled nut

### Terminal design

- P10** Blade terminal 6.3 x 0.8 mm (IEC 61210)
- P30** Blade terminal 2.8 x 0.8 mm (IEC 61210)
- PR** PR Soldering pins for horizontal PCB mounting (104 version only)
- PR3** PR3 Soldering pins for vertical PCB mounting (104 version only)

### Current rating range

0.05 ... 10 A

**106 - P30 - 5 A** Ordering example

<sup>(1)</sup> Use this version for configuration with XR38 power entry module

Please observe our minimum ordering quantities.

## Current ratings and internal resistance values

Current rating (A)	Internal resistance (Ω)	Current rating (A)	Internal resistance (Ω)
0.05	285	1.8	0.28
0.08	134	2	0.25
0.1	81	2.5	0.18
0.2	22	3	0.11
0.3	8.7	3.5	0.076
0.4	5.5	4	0.067
0.5	3.3	4.5	0.051
0.6	2.45	5	≤ 0.05
0.7	1.6	6	≤ 0.05
0.8	1.45	7	≤ 0.05
1	0.9	8	≤ 0.05
1.2	0.6	10	≤ 0.05
1.5	0.4		

## Dimensions

### 104-PR

#### Dimensions

104 - PR  
0.05...6 A

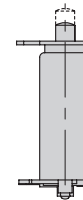
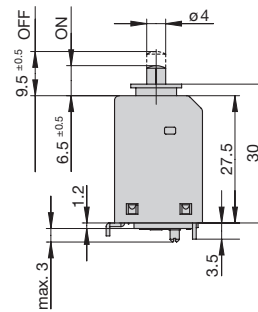

104 - PR  
7...10 A

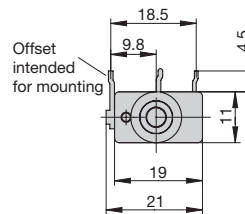
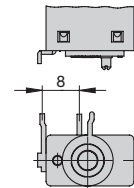

#### PCB drilling hole diagram

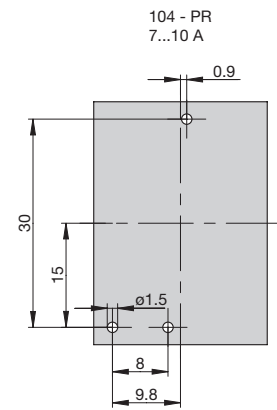
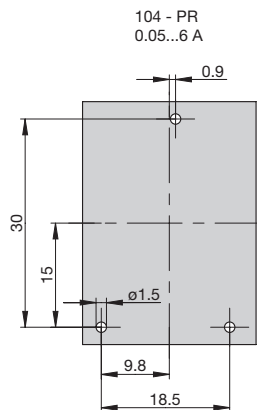

**Dimensions**

**104-PR3**

Dimensions

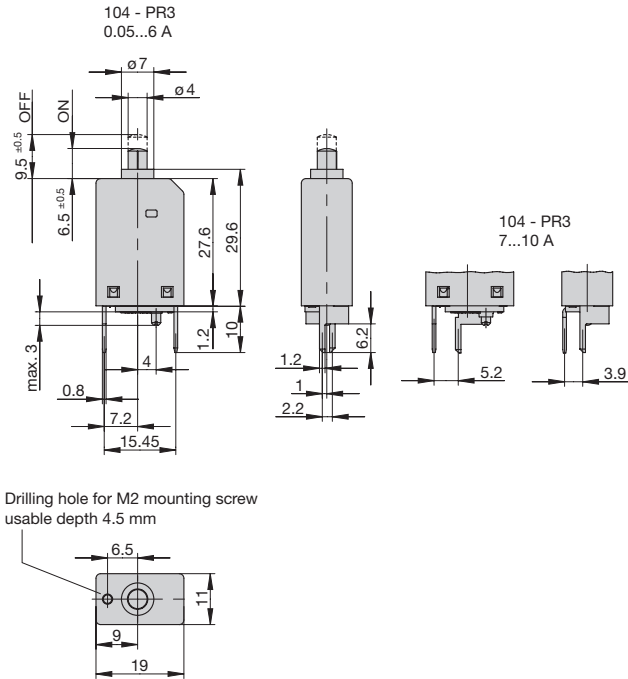

PCB drilling hole diagram

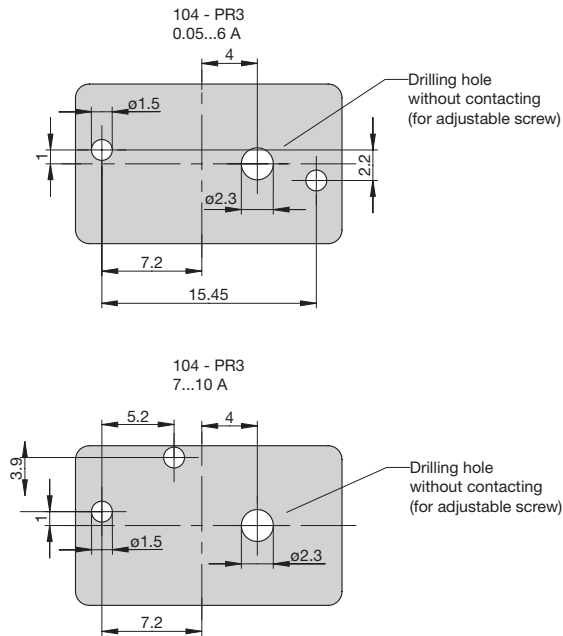

**Dimensions**

**104-P30**

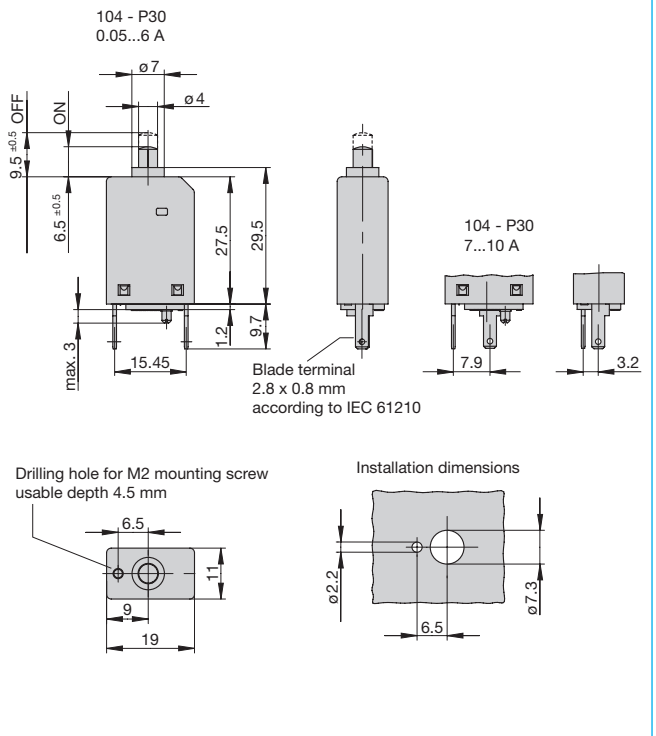

**105-P30**

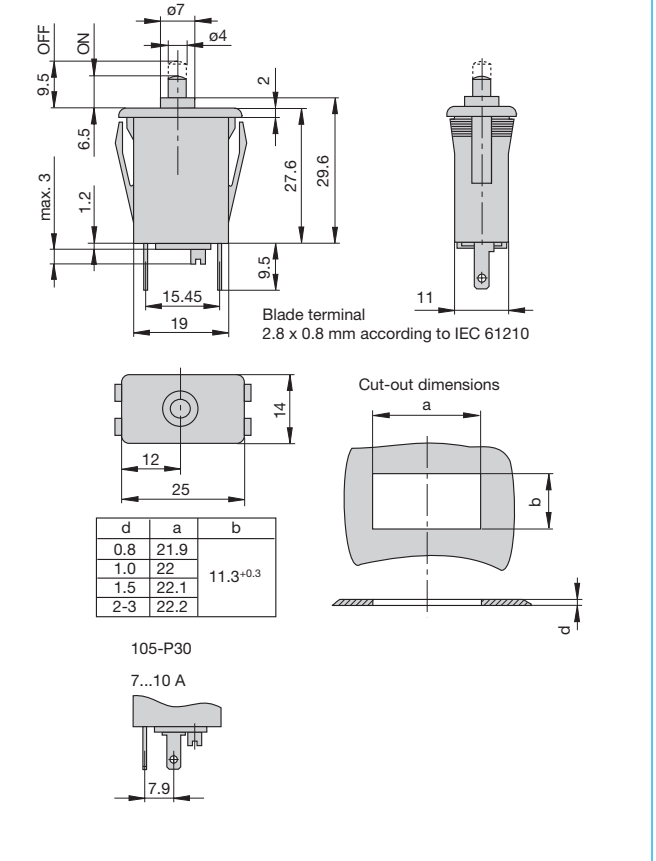

**Dimensions**

**106-P30**

3/8-27UNS-2A  
tightening torque max. 0.8 Nm

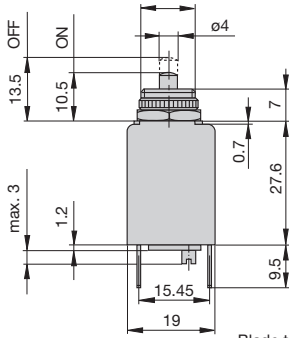

Blade terminals 2.8 x 0.8 mm according to IEC 61210

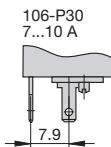
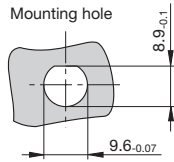
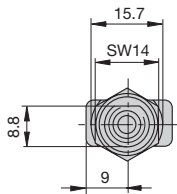

**106-M2**

3/8-27UNS-2A  
tightening torque max. 0.8 Nm

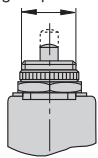

Mounting hole

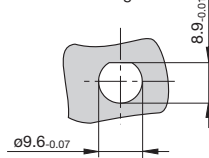

**Terminal types**

**104/105/106-P10**

0.05...6 A

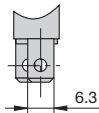
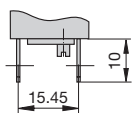

7...10 A

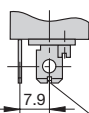

Blade terminal 6.3 x 0.8 mm according to IEC 61210

Polarizing tooth

**Installation drawing**

**104-P10  
104-P30**

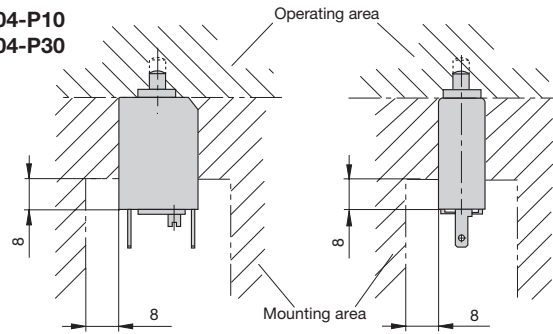

**105-...**

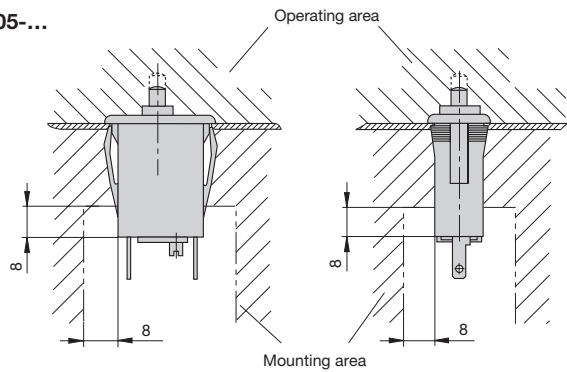

**106-...**

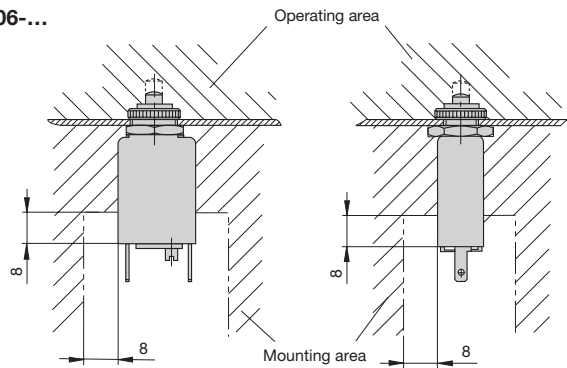

**Schematic diagrams**

**Types 104  
105  
106**

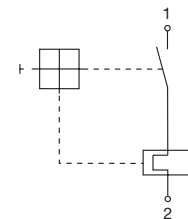

Time/current characteristics

Ambient temperature 23 °C

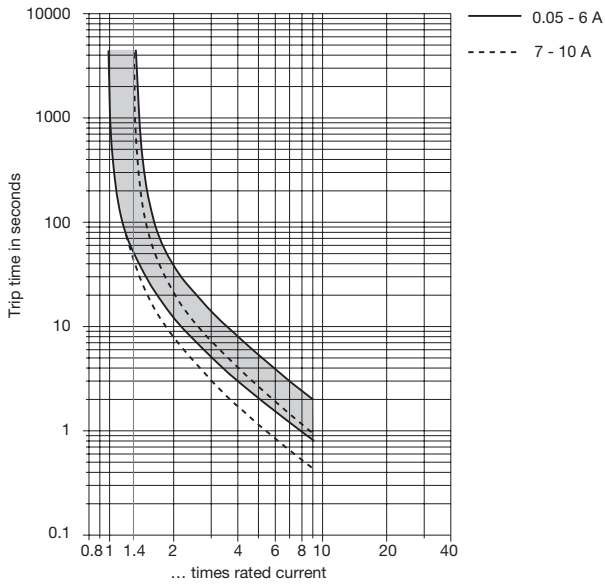

The time/current characteristic depends on the ambient temperature. In order to eliminate nuisance tripping, please multiply the current rating with a temperature factor (see Technical Information chapter)

Ambient temperature [°C]	-20	-10	0	+23	+40	+50	+60
Temperature factor	0.76	0.84	0.92	1	1.08	1.16	1.24

Accessories

**Water splash cover (transparent)/  
knurled nut assembly (type 106-... only)**  
X 201 285 01 (IP64)

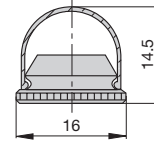

**Knurled nut 3/8", plastic (standard)**  
Y 307 117 02

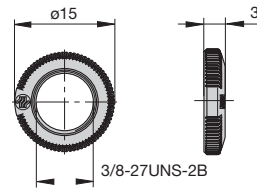

**Hex nut 3/8", nickel-plated brass**  
Y 300 192 01

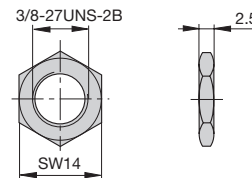

All information and data given on our products are accurate and reliable to the best of our knowledge, but E-T-A does not accept any responsibility for the use in applications which are not in accordance with the present specification. E-T-A reserves the right to change specifications at any time in the interest of technical improvement. Dimensions are subject to change without notice. Please enquire for the latest dimensional drawing with tolerances if required. All dimensions, data, pictures and descriptions are for information only and are not binding. Amendments, errors and omissions excepted. Ordering codes of the products may differ from their marking.