

Description

The compact 19" Power-D-Box features aluminium profiled cross members with an anodised front plate. The panel cutout accommodates up to 30 positions numbered 1 to 30. Blanks cover unused positions, with 6, 12, 24 or 30 being "open".

The rack can be fitted with plug-in type circuit breakers 3600/3900 and 2210, electronic circuit breakers ESS20 or electronic circuit protector ESX10 or E-T-A Solid State Remote Power Controllers (SSRPC) E-1048-600/700. Please specify the correct option according to the ordering information shown, as different depths as well as different heights of the front cut-out must be allowed for. The devices are plugged into sockets 63-P10-Si (6 positions each). These sockets (S1...S5) are provided with 6.3 mm blade terminals on the rear.

Four busbars (X1...X4) with 6 (signalisation) or 15 (feed) positions each (6.3 mm blade terminals) provide easy terminal connection.

Prewired options available ex factory are:

- Parallel connected feed (2.5 mm²) with separate supply for each socket via busbars X1 and X2.
Choice of wiring colours: black, red, blue, grey. Outputs are not connected.
- Parallel connected auxiliary contacts (N/C) grouped per socket, 1 mm², via busbars X3 (supply) and X4 (signalisation).
Choice of wiring colours: black, red, blue, grey.
- Series connected auxiliary contacts (N/O) of all positions with 1 mm², via busbars X3 (feed) and X4 (signalisation).
Choice of wiring colours: black, red, blue, grey.
- Custom designed connection according to specification.

Other fittings, e.g. back-up fuse, separate circuits or redundancy, multipole circuits, screw terminals, custom designed markings etc., are available to special order (please enquire).

A compact printed circuit board with rear screw terminals is available as an alternative to the standard cable wiring.

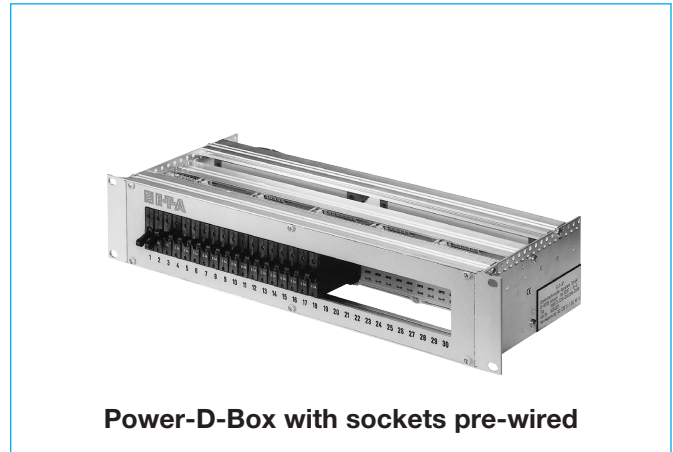

Power-D-Box with sockets pre-wired

Technical data

19" Power-D-Box	length: 84 modules (426.72 mm) height: 2 U (88.90 mm) depth: 205...295 mm (depending on the selected version) material: aluminium, anodized
Front cutout for 30 positions, numbered 1 through 30	1 socket = 6 positions (No. 1 - 6) 2 sockets = 12 positions (No. 1 - 12) 3 sockets = 18 positions (No. 1 - 18) 4 sockets = 24 positions (No. 1 - 24) 5 sockets = 30 positions (No. 1 - 30) blanks cover unused sockets.
Mounting socket	polarised E-T-A mounting socket type 63-P10-Si (6 positions) rear blade terminals 6.3 mm max. load: 16 A continuous
Busbars Feed (X1, X2)	15-way for 6.3 mm blade terminals max. current rating: 63 A
Busbars Auxiliary contacts (X3, X4)	6-way for 6.3 mm blade terminals max. current rating: 32 A
Feed	busbar 50 A per socket (= 6 positions) HO7Z-K cables 2.5 mm ² with fully insulated 6.3 mm blade terminals to VBG 4 one cable per socket max. current rating: 20 A
Auxiliary contact wiring	HO7Z-K cables 1 mm ² with fully insulated 6.3 mm blade terminals to VBG 4 max. current rating: 4 A
Wire colour option	black, red, blue or grey
Voltage rating	AC 250 V/DC 65 V
Housing ground/earth	on the inside via M6 screw by means of ring cable lug (two with redundant systems)

Ordering information

Type No.

19BGT 19" Power-D-Box with sockets pre-wired

Height

1 1 U

2 2 U

3 3 U

Prepared for circuit breaker types (supplied separately)

2210 for circuit breaker type 2210

3600 for circuit breaker type 3600/3900

1048 for SSRPC E-1048-600

ESS20 for electronic circuit breaker type ESS20

ESX10 for electronic circuit protector type ESX10

Number of positions

06 6-poles

12 12-poles

18 18-poles

24 24-poles

30 30-poles

nn number of poles (special version)

Feed prewired

A0 without

R0 without, redundant

A2 line feed pre-wired (2.5 mm²) 1-pole (or 1 circuit)

R2 line feed pre-wired 1-pole redundant

A4 line feed pre-wired (2.5 mm²) 2-pole (or 2 circuits)

R4 line feed pre-wired 2-pole redundant

A6 line feed pre-wired 3-pole (or 3 circuits)

R6 line feed pre-wired 3-pole redundant

A8 line feed pre-wired 4-pole (or 4 circuits)

R8 line feed pre-wired 4-pole redundant

Wire colour (not with A0 + R0)

1-pole

SW black

RT red

BL blue

GR grey

2-pole

RB 1st pole red, 2nd pole blue

RS 1st pole red, 2nd pole black

SB 1st pole black, 2nd pole blue

3-pole

SW 1st pole to 3rd pole black

SB 1st pole to 2nd pole black, 3rd pole blue

4-pole

SW 1st pole to 4th pole black

SB 1st pole to 3rd pole black, 4th pole blue

Auxiliary contacts prewired (1 mm²)

B0 without

B1 auxiliary contacts connected in series (please consider plug-in device)

B2 auxiliary contacts connected in parallel (please consider plug-in device)

Wire colour (not with B0)

SW black

RT red

BL blue

GR grey (standard)

S... customer-specific version

19BGT - 2 - 2210 - 24 A2 SW - B1 GR - S... ordering example

Dimensions

Bottom view
19BGT-2-ESS20-30A0-B0

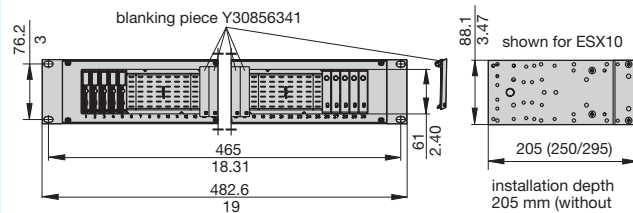
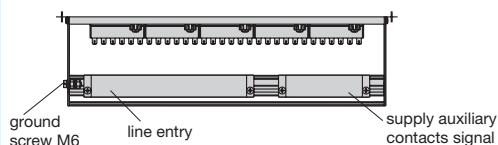

installation depth 205 mm (without additional wiring, standard)

installation depth 250/295 mm, depending on additional wiring

Top view

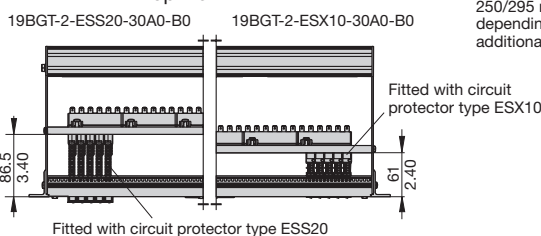

Bottom view
19BGT-2-2210-30A0-B0

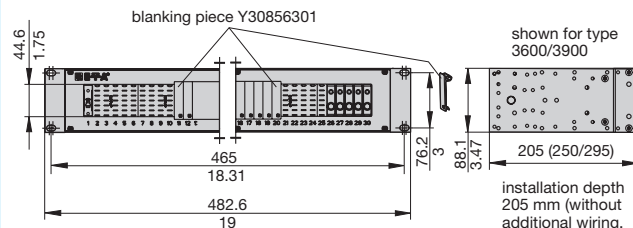
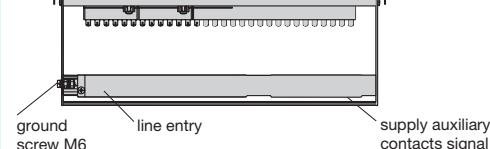

installation depth 205 mm (without additional wiring, standard)

installation depth 250/295 mm, depending on additional wiring

Top view

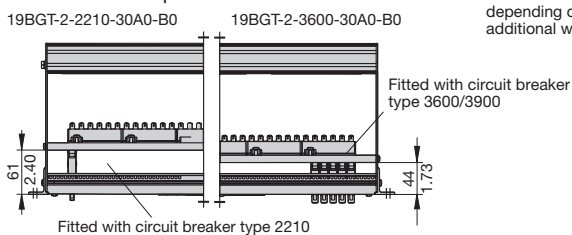

This is a metric design and millimeter dimensions take precedence (mm/inch)

Internal connection diagrams

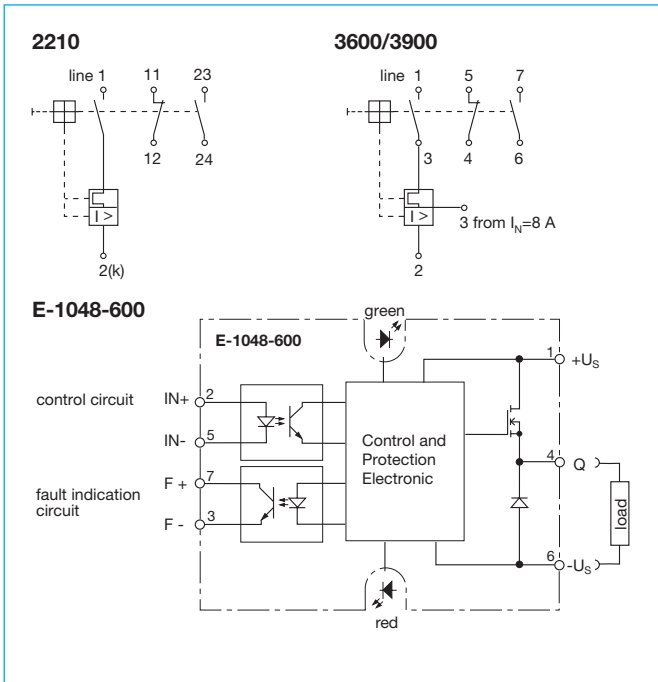

ESS20-003- ... (group signalisation with change over)

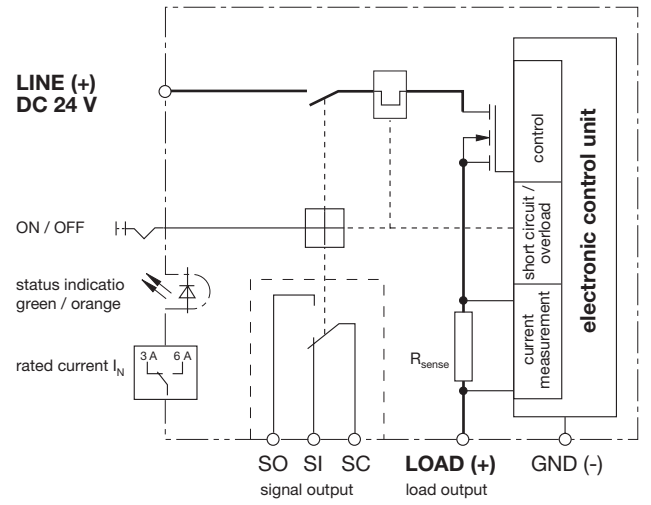

ESX10-124-...

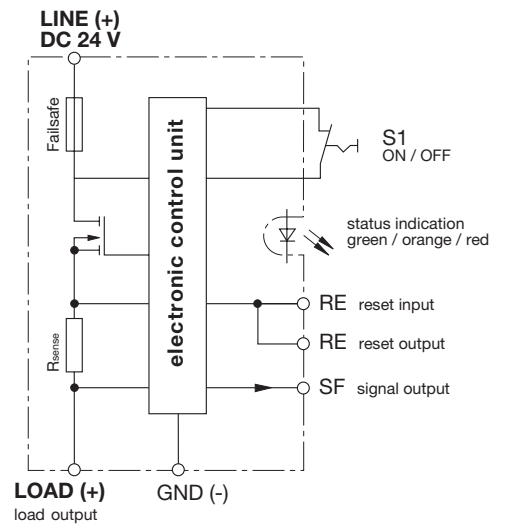

1

Termination

19BGT-2-2210/3600-30A0-B1

pre-wiring of signalisation,
group signalisation - series connection

line terminal X22150301
10...16 (25) mm²,
plug-on type (optional)

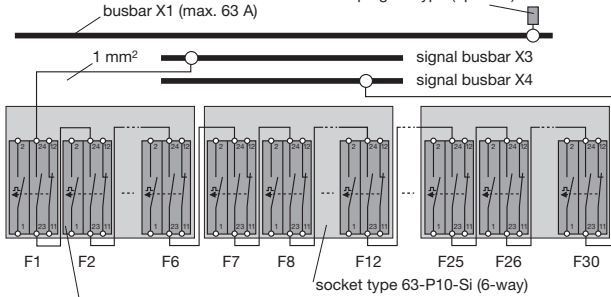

circuit breaker types 2210-S21x.../3600.../3900
plug-in type (not included)

load terminal pin 1, blade terminals 6.3 mm
auxiliary contact terminals:
11-12 make contact, blade terminals 6.3 mm
auxiliary contact terminals:
23-24 break contact, blade terminals 6.3 mm

pin assignment
socket 63-P10-Si
(per pole)

	2210	3600/ 3900
2	2	1
12	4	4
24	6	6
n.c.	3	3
23	7	7
11	5	5
1	2	2

19BGT-2-2210/3600-30A0-B2

pre-wiring of signalisation,
group signalisation - parallel connection

line terminal X22150301
10...16 (25) mm²,
plug-on type (optional)

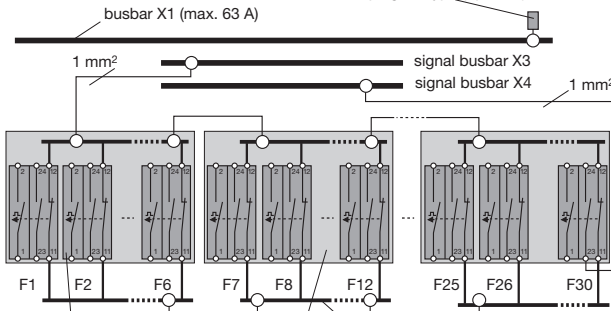

circuit breaker types
2210-S21x.../3600.../3900...
plug-in type (not included)

load terminal pin 1, blade terminals 6.3 mm
auxiliary contact terminals:
11-12 make contact, blade terminals 6.3 mm
auxiliary contact terminals:
23-24 break contact, blade terminals 6.3 mm

pin assignment
socket 63-P10-Si
(per pole)

	2210	3600/ 3900
2	2	1
12	4	4
24	6	6
n.c.	3	3
23	7	7
11	5	5
1	2	2

19BGT-2-2210/3600-30A2-B0

pre-wiring of line feed,
1-pole protected by return busbar

line terminal X22150301
25 mm², plug-on type (optional)

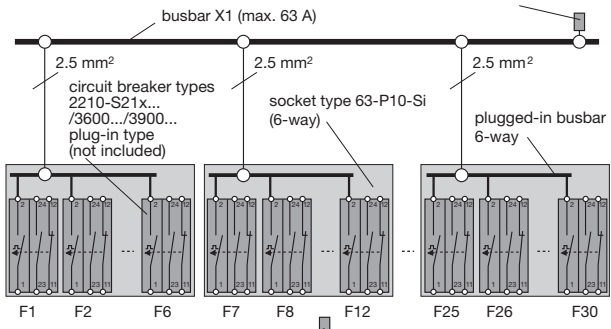

return busbar X2
(max. 63 A)

load terminals 1. pole to PIN 1, blade terminals 6.3 mm
load terminals 2. pole to return busbar X2,
blade terminals 6.3 mm
auxiliary contact terminals: 11-12 make contact,
blade terminals 6.3 mm
auxiliary contact terminals: 23-24 break contact,
blade terminals 6.3 mm

pin assignment
socket 63-P10-Si
(per pole)

	2210	3600/ 3900
2	2	1
12	4	4
24	6	6
n.c.	3	3
23	7	7
11	5	5
1	2	2

19BGT-2-2210/3600-30R2-B0

pre-wiring of line feed,
1-pole protected, redundant

line terminal X22150301
25 mm², plug-in type (optional)

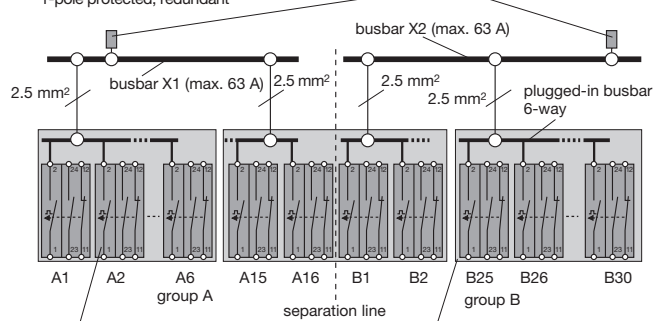

circuit breaker types
2210-S21x.../3600.../3900
plug-in type (not included)

load terminal pin 1, blade terminals 6.3 mm
auxiliary contact terminals:
11-12 make contact, blade terminals 6.3 mm
auxiliary contact terminals:
23-24 break contact, blade terminals 6.3 mm

socket type
63-P10-Si (6-way)

pin assignment
socket 63-P10-Si
(per pole)

	2210	3600/ 3900
2	2	1
12	4	4
24	6	6
n.c.	3	3
23	7	7
11	5	5
1	2	2

19BGT-2-2210/3600-30A4-B0

pre-wiring of line feed,
2-pole protected/switched

line terminal X22150301
25 mm², plug-in type (optional)

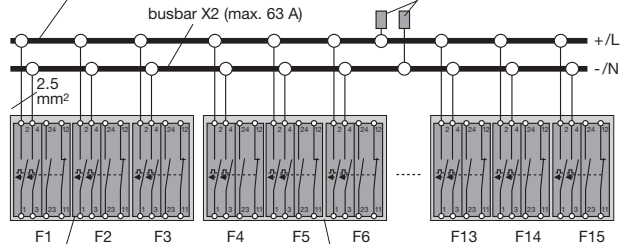

circuit breaker types
2210-S21x.../3600.../3900
plug-in type (not included)

load terminals:
Pin 1 (+/-), Pin 3 (+/-), blade terminal 6.3 mm
auxiliary contact terminals:
11-12 make contact, blade terminals 6.3 mm
auxiliary contact terminals:
23-24 break contact, blade terminals 6.3 mm

socket type
63-P10-Si (6-way)

pin assignment
socket 63-P10-Si
(per pole)

	2210	3600/ 3900
2	2	1
12	4	4
24	6	6
n.c.	3	3
23	7	7
11	5	5
1	2	2

19BGT-2-ESS20/ESX10-30A4-B0

pre-wiring of line feed,
1-pole protected

line terminal X22150301
10...16 (25) mm²,
plug-on type (optional)

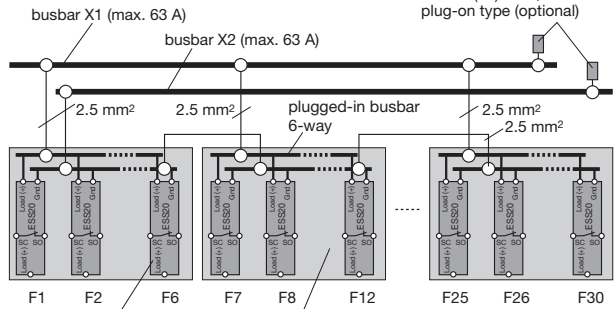

electronic circuit breaker type ESS20
or electronic circuit protector
plug-in type (not included)

load terminals LOAD(+), blade terminals 6.3 mm
auxiliary contact terminals SC-SO make contact,
blade terminals 6.3 mm

socket type
63-P10-Si (6-way)

pin assignment
socket 63-P10-Si
(per pole)

	ESS20	ESX10
LINE	LINE	1LINE
Gnd	Gnd	11Gnd
SC	SC	13SC
n.c.	n.c.	n.c.
SO	SO	14SO
LOAD	LOAD	2LOAD

Accessories

Blanking piece for Power-D-Box
(types 3600/3900, 2210)
Y 308 563 01

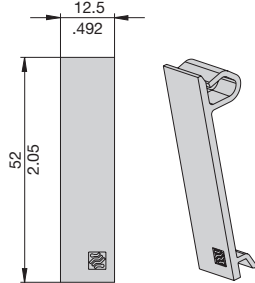

Blanking piece for Power-D-Box
(types ESS20/ESX10)
Y 308 563 41

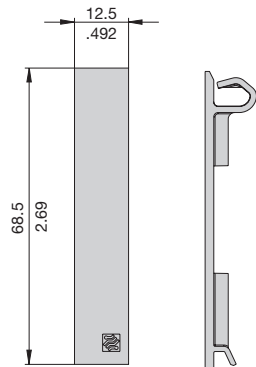

For removing the blanking piece:
push in the screwdriver as shown below

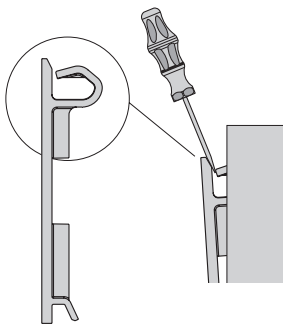

Withdrawal tool for ESS20/ESX10
Y 308 602 01

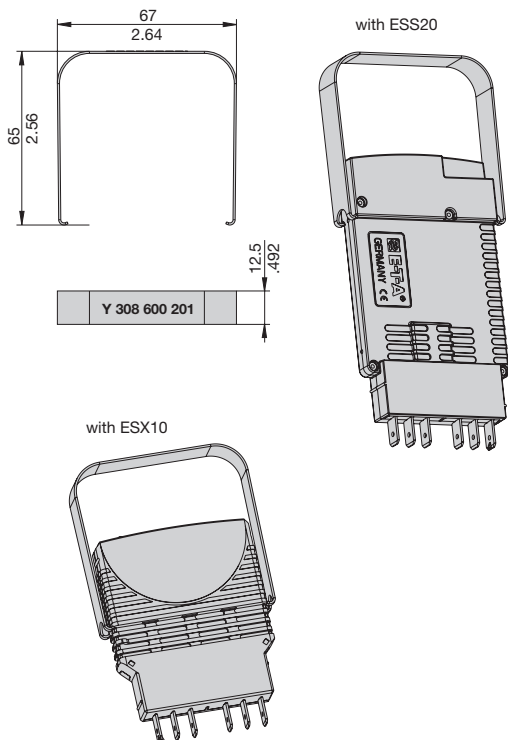

Line Terminal (max. 63 A)
X 221 503 01
max. tightening torque 3.0 Nm

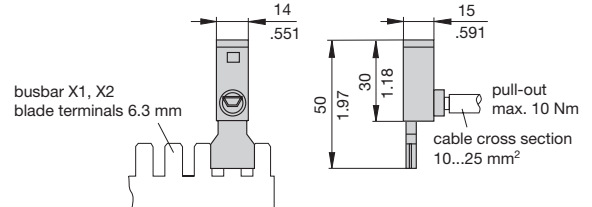

Caution: cables must not be connected with terminal plugged in

Jumper
to bypass looped through unused auxiliary contacts
(series connection)

X 222 066 01

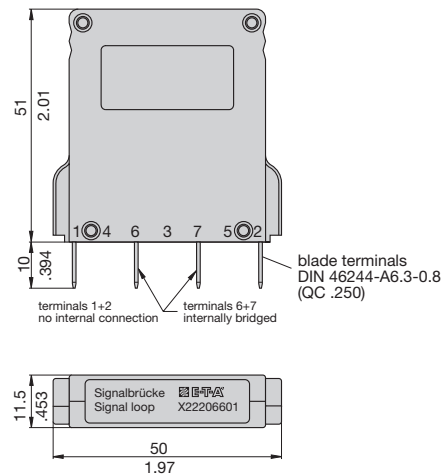

This is a metric design and millimeter dimensions take precedence ($\frac{\text{mm}}{\text{inch}}$)

All dimensions without tolerances are for reference only. In the interest of improved design, performance and cost effectiveness the right to make changes in these specifications without notice is reserved. Product markings may not be exactly as the ordering codes. Errors and omissions excepted.

