

Description

Single pole compact high performance thermal circuit breaker with tease-free, trip-free, snap action mechanism and push/pull on/off manual actuation (M-type TO CBE to EN 60934). An indicator band on the push button clearly shows the tripped/off position. Threadneck panel mounted in tracked vehicle and aircraft/general purpose versions, with optional auxiliary contacts.

Typical applications

Extra low voltage wiring systems on all types of vehicles for land, sea and air, battery powered machines, process control.

Ordering information

Type No.	482
single pole thermal circuit breaker	
Mounting	
G threadneck panel mounting	
Threadneck design	
1 M 12x1 nickel plated	
2 M 12x1 black	
3 15/32-UN-2A black	
6 M12x1x8 black, without locating pin, push button marking as with 482-G2..	
7 M12x1x6,4 black, without locating pin, push button marking as with 482-G1..	
Hardware - washer for threadneck	
0 without hardware	
1 corrugated washer 12/15, fitted	
2 serrated lock washer 12/15, fitted (MS 35333-136)	
3 serrated lock washer 12/15, bulk shipped (MS 35333-136)	
Hardware - hex nut for threadneck	
0 without hardware	
1 hex nut M12x1 nickel plated	
2 hex nut M12x1 black	
3 hex nut 15/32-UN-2B black, fitted	
4 hex nut 15/32-UN-2B black, bulk shipped	
Terminal design (main terminals)	
K1 screw terminals with metric thread M4	
J1 screw terminals with inch thread 8-32-UNC-2B	
R1 round connector ø6	
Characteristic curve	
M1 thermal 1.15-1.4 I _N	
Terminal screws	
A flat head screw M4x6, ISO 1580, fitted	
B Phillips screw 8-32UNC-2Ax6 (MS 51957-41), fitted	
F Phillips screw M4x6 (ISO 7045), bulk shipped	
H socket head cap screw M4x6 (DIN 7984), fitted	
K hex screw 8-32UNC-3Ax7.6 fitted	
Terminal washers	
0 without lock washer	
1 lock washer DIN 137-B4, fitted	
2 lock washer 4.3, fitted, MS 35338-137	
3 lock washer 4.3, bulk shipped (MS 35338-137)	
5 lock washer 4.3/9, fitted	
6 lock washer DIN 137-B4, bulk shipped	
Auxiliary contact	
S0 without auxiliary contacts	
S1 with auxiliary contact (NC)	
S5 with polarized aux. contact (NC)	
Barrier	
(blank) without barrier	
T with barrier, 31 mm wide	
Current ratings	
0.1...50 A	
482 - G 1 1 1 - K1 M1 - A 1 S1 . - 10 A ordering example	

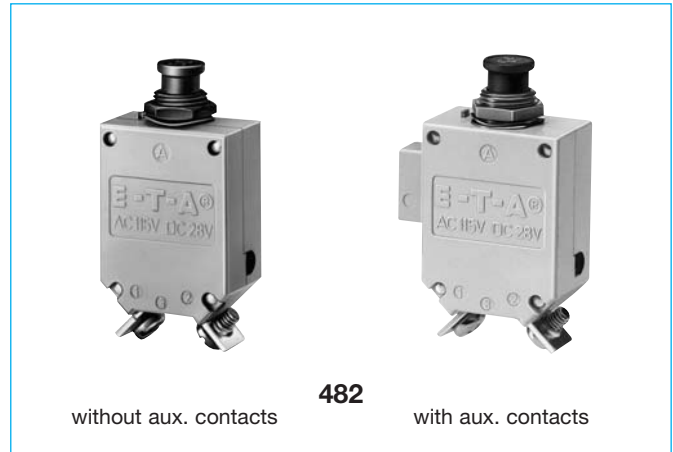

without aux. contacts

482

with aux. contacts

Technical data

Voltage rating	AC 115 V (400 Hz); DC 28 V AC 230 (50/60 Hz) to special order	
Current rating range	0.1...50 A	
Auxiliary circuit	0.5 A, DC 28 V	
Typical life	10,000 operations mechanical 5,000 operations at I _N	
Ambient temperature	-55...+75 °C (-67...+167 °F)	
Insulation co-ordination (IEC 60664 and 60664A)	rated impulse withstand voltage 1.5 kV	pollution degree 3
Dielectric strength (IEC 60664 and 60664A)	test voltage operating area main to aux. circuit	AC 1,500 V AC 1,500 V
Insulation resistance	> 100 MΩ (DC 500 V)	
Interrupting capacity I_{cn}	0.1...2.5 A 3...3.5 A 4...7 A 7.5...50 A 35...50 A	15 x I _N 250 A DC / 150 A AC 500 A 6,000 A DC / 1,000 A AC with auxiliary contact: 3,000 A DC / 1,000 A AC
Interrupting capacity (UL 1077)	I _N 0.1...50 A	U _N DC 72 V 5,000 A
Degree of protection (IEC 60529/DIN 40050)	operating area IP40 terminal area IP00	
Vibration	10 g (55-2000 Hz), ± 0.76 mm (10-55 Hz) to VG 95210, sheet 19/IEC 60068-2-6, test Fc	
Shock	50 g (11 ms) to VG 95210, sheet 28/IEC 60068-2-27, test Ea	
Corrosion	48 hours at 5 % salt mist to VG 95210, sheet 2/IEC 60068-2-11, test Ka	
Humidity	240 hours at 95 % RH to VG 95210, sheet 7/IEC 60068-2-3, test C	
Explosion	to VG 95210, sheet 10/MIL-STD-202, meth. 109	
Mass	approx. 43 g without auxiliary contact approx. 46 g with auxiliary contact	

Approvals

Authority	Voltage ratings	Current ratings
VG 95345 T21	DC 28 V	0.1...50 A
QPL, Canada	DC 28 V	0.5...35 A
UL, CSA	DC 72 V	0.1...50 A

Previous ordering codes:
482-N-MS = 482-G111-K1M1-A1S0-...A
482-MS = 482-G212-K1M1-A1S0-...A

Dimensions 482-G3...

482-G323-J1M1-B2 (MS 25 244)

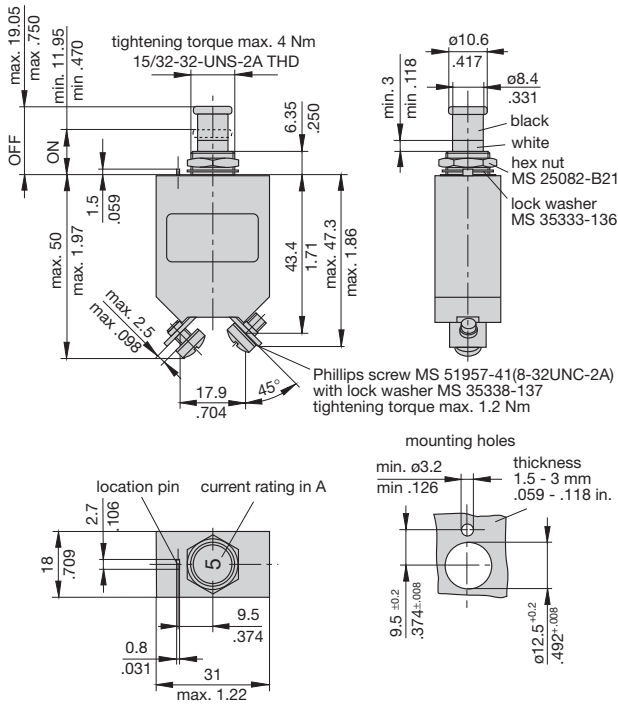

482-G323-J2...-E3S0T

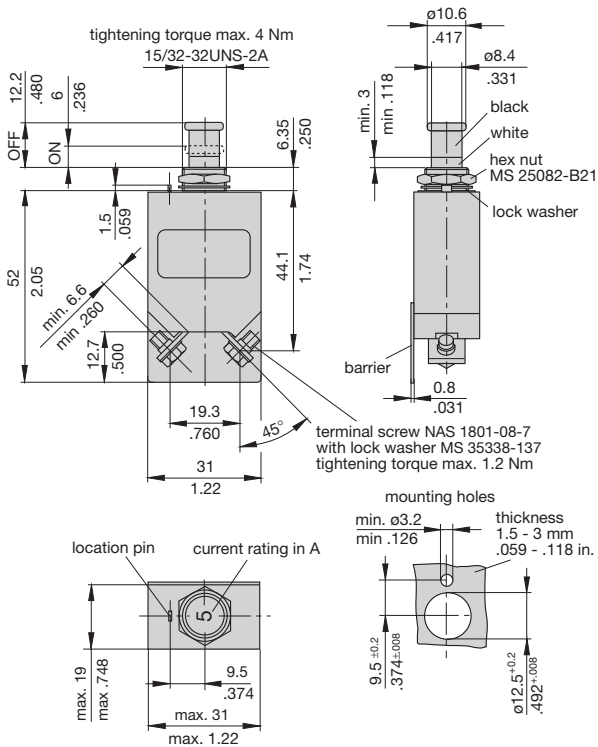

Typical time/current characteristics

0.1...2.5 A

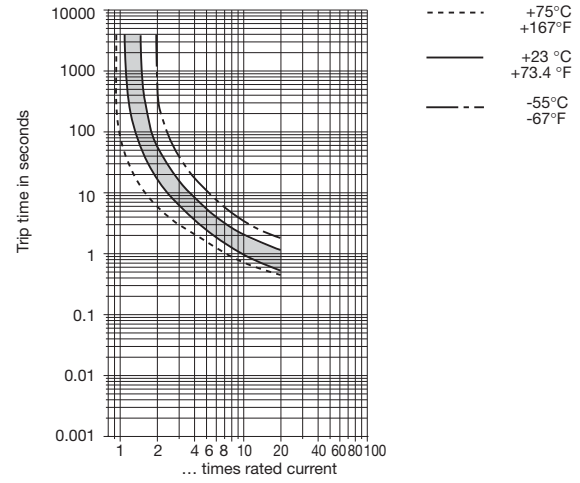

3...50 A

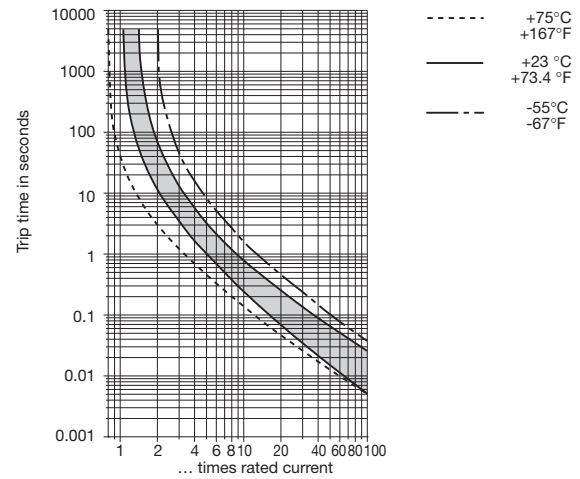

Internal connection diagrams

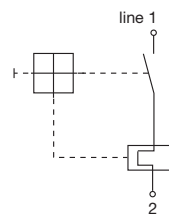

with auxiliary contact

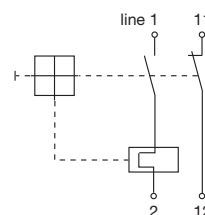

with polarized auxiliary contact

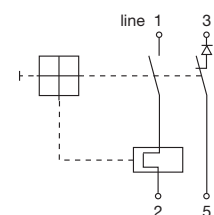

This is a metric design and millimeter dimensions take precedence ($\frac{\text{mm}}{\text{inch}}$)

Accessories (approved to VG 95345, part 23)

Splash cover /hex nut assembly with O ring (IP66)
X 200 801 08 - nickel plated nut M12x1, transparent cover
X 200 801 03 - matt black finish nut M12x1, black cover

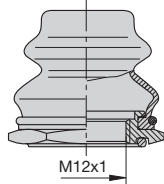

Splash cover black /hex nut assembly with O ring (IP54)
X 200 802 01 - nickel plated nut M12x1
X 200 802 02 - matt black finish nut M12x1

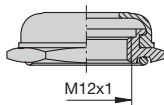

Actuator extension (black)
 to be fitted on the push button
X 200 803 01

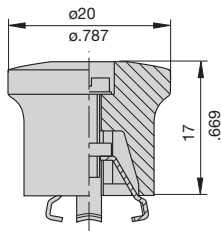

Accessories

Identification collar to be snapped on the push button

Y 307 004 01 black
Y 307 004 02 white
Y 307 004 03 red
Y 307 004 04 green
Y 307 004 05 blue

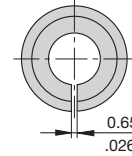
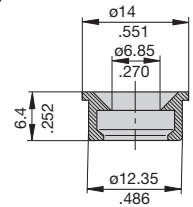

Lock out ring to block the push button in OFF position

Y 307 005 01 red
Y 307 005 02 black

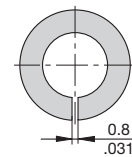
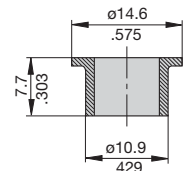

This is a metric design and millimeter dimensions take precedence ($\frac{\text{mm}}{\text{inch}}$)

All dimensions without tolerances are for reference only. In the interest of improved design, performance and cost effectiveness the right to make changes in these specifications without notice is reserved. Product markings may not be exactly as the ordering codes. Errors and omissions excepted.