

## Description

One, two and three pole thermal-magnetic circuit breakers with trip-free mechanism and toggle actuation (S-type TM CBE to EN 60934/IEC 934). Featuring a combi-foot design for both symmetric and asymmetric rail mounting. Available with auxiliary contact (1 x N/O or 1 x N/C) for status signalling. Two and three pole models are internally linked to ensure that both/all poles trip in the event of an overload on one pole, even if the actuator is held in the ON position. This CBE can be supplied in current ratings up to 32 A with a choice of characteristic curves. All screw terminals are recessed for safety. Approved to CBE standard EN 60934 (IEC 60934).

## Typical applications

Process control equipment, robotics, machine tool control, communications systems, instrumentation.

## Ordering information

<b>Type No.</b>	2210	single and multipole thermal-magnetic circuit breaker
<b>Mounting</b>	T	rail mounting
<b>Actuator design</b>	2	toggle
<b>Number of poles</b>	1	single pole protected
	2	2-pole protected
	3	3-pole protected
<b>Accessories</b>	0	without accessories
<b>Terminal design (main contacts)</b>	K0	screw terminals
<b>Characteristic curve</b>	F1	fast acting: therm. 1.01-1.4xI <sub>N</sub> ; magn. 2-4xI <sub>N</sub> DC (DC only)
	F2	fast acting: therm. 1.01-1.4xI <sub>N</sub> ; magn. 3.5-6.5xI <sub>N</sub> AC/4.5-8.5xI <sub>N</sub> DC
	M1	standard delay: therm. 1.01-1.4xI <sub>N</sub> ; magn. 6-12xI <sub>N</sub> AC, 7.8-15.6xI <sub>N</sub> DC
	T1	delayed: therm. 1.01-1.4xI <sub>N</sub> ; magn. 10-20xI <sub>N</sub> AC
<b>Auxiliary contact design</b>	H	without intermediate position
<b>Auxiliary contacts</b>	1	with auxiliary contacts
	2	auxiliary contacts on pole 1 only (multipole devices)
<b>Auxiliary contact function (see diagrams)</b>	2	1 N/O contact
	3	1 N/C contact
<b>Auxiliary contact - terminal design</b>	1	screw terminals
<b>Current ratings</b>	0.1...32 A	
<b>2210 - T 2 1 0 - K0 M1- H 1 2 1 - 10 A</b> ordering example		

## Preferred types

**NEW**

Preferred types	Standard current ratings (A)										
1-pole	0.5	1	2	3	4	5	6	8	10	16	20
2210-T210-K0M1-H121-	x	x	x	x	x	x	x	x	x	x	x
2-pole	0.5	1	2	3	4	5	6	8	10	16	20
2210-T220-K0M1-H221-			x		x		x		x	x	x

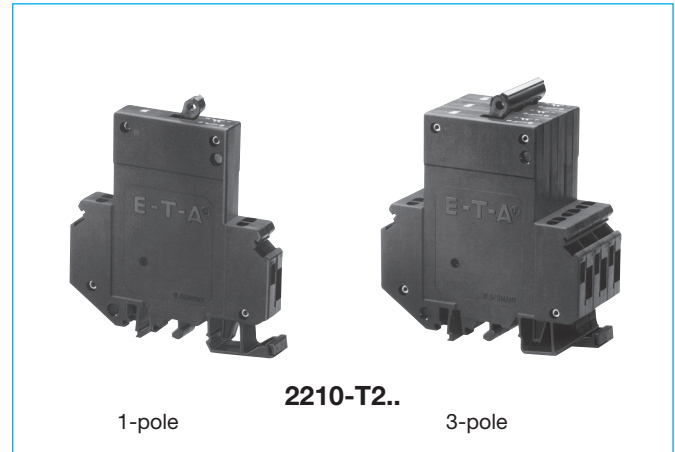

## Technical data

**For further details please see chapter: Technical Information**

Voltage rating	AC 250 V; 3 AC 433 V (50/60 Hz); DC 65 V (UL: AC 277/480 V; DC 65 V)	
Current rating range	0.1...32 A for curves M1, T1 0.1...16 A for curves F1, F2	
Auxiliary circuit	1 A, AC 240 V/DC 65 V, resistive	
Typical life	3 AC 433 V; AC 250 V: 0.1...25 A 10,000 operations at 1 x I <sub>N</sub> , inductive DC 65 V: 0.1...32 A 10,000 operations at 1 x I <sub>N</sub> , inductive 3 AC 433 V; AC 250 V: 32 A 10,000 operations at 1 x I <sub>N</sub> , resistive	
Ambient temperature	-30...+60 °C (-22...+140 °F) T 60	
Insulation co-ordination (IEC 60664 and 60664 A)	rated impulse withstand voltage 2.5 kV	pollution degree 2 reinforced insulation in operating area
Dielectric strength (IEC 60664 and 60664A)	test voltage operating area main/aux. circuit pole/pole	AC 3,000 V AC 3,000 V AC 1,500 V
Insulation resistance	> 100 MΩ (DC 500 V)	
Interrupting capacity I <sub>cn</sub>	0.1...5 A 6...32 A	400 A 800 A
Interrupting capacity (UL 1077)	curves F1, F2, M1, T1:	0.1...16 A 2,500 A (at DC 32 V)
<b>I<sub>N</sub></b>	<b>0.1...16 A</b>	<b>20...25 A</b>
AC 277 V 1-pole	5,000 A	2,000 A
AC 277/480 V 2-/3-pole	5,000 A	2,000 A
DC 65 V	2,000 A	2,000 A
Degree of protection (IEC 60529/DIN 40050)	operating area IP30 terminal area IP20	
Vibration	curves F1, F2: 3 g (57-500 Hz), ± 0.23 mm (10-57 Hz) curves M1, T1: 5 g (57-500 Hz), ± 0.38 mm (10-57 Hz)	to IEC 60068-2-6, test Fc 10 frequency cycles/axis
Shock	curves F1, F2: 25 g (11 ms), directions 1, 2, 3, 4, 5 10 g (11 ms), direction 6 curves M1, T1: 25 g (11 ms), directions 1, 2, 3, 4, 5 20 g (11 ms), direction 6	to IEC 60068-2-27, test Ea
Corrosion	96 hours at 5 % salt mist to IEC 60068-2-11, test Ka	
Humidity	240 hours at 95 % RH to IEC 60068-2-78, test Cab	
Mass	approx. 60 g per pole	

## Standard current ratings and typical internal resistance values

Current rating (A)	Internal resistance (Ω)			
	F1	F2	M1	T1
	fast acting for DC only	fast acting delay for AC + DC	standard for AC+DC	delayed low resistance for AC only
0.1	162	162	92	81
0.2	39.3	39.3	26.1	24.2
0.3	17.5	17.5	11.6	10.4
0.4	9.2	9.2	6.6	6.0
0.5	6.8	6.8	4.1	3.9
0.6	4.2	4.2	3	2.7
0.8	2.8	2.8	1.65	1.53
1	1.6	1.6	1.10	0.98
1.5	0.78	0.78	0.47	0.42
2	0.42	0.42	0.28	0.24
2.5	0.26	0.26	0.183	0.17
3	0.18	0.18	0.124	0.12
4	0.12	0.12	0.077	0.073
5	0.092	0.092	0.063	0.055
6	0.054	0.054	0.045	0.039
8	0.025	0.025	≤ 0.02	≤ 0.02
10	0.022	0.02	≤ 0.02	≤ 0.02
12	≤ 0.02	≤ 0.02	≤ 0.02	≤ 0.02
16	≤ 0.02	≤ 0.02	≤ 0.02	≤ 0.02
20	-	-	≤ 0.02	≤ 0.02
25	-	-	≤ 0.02	≤ 0.02
32	-	-	≤ 0.02	≤ 0.02

## Approvals

Authority	Voltage ratings	Current ratings
GL, VDE (EN 60934)	3 AC 433 V; AC 250 V; DC 65 V	0.1...32 A
UL, CSA	AC 277 V; AC 277/480 V; DC 65 V	0.1...32 A

## Dimensions

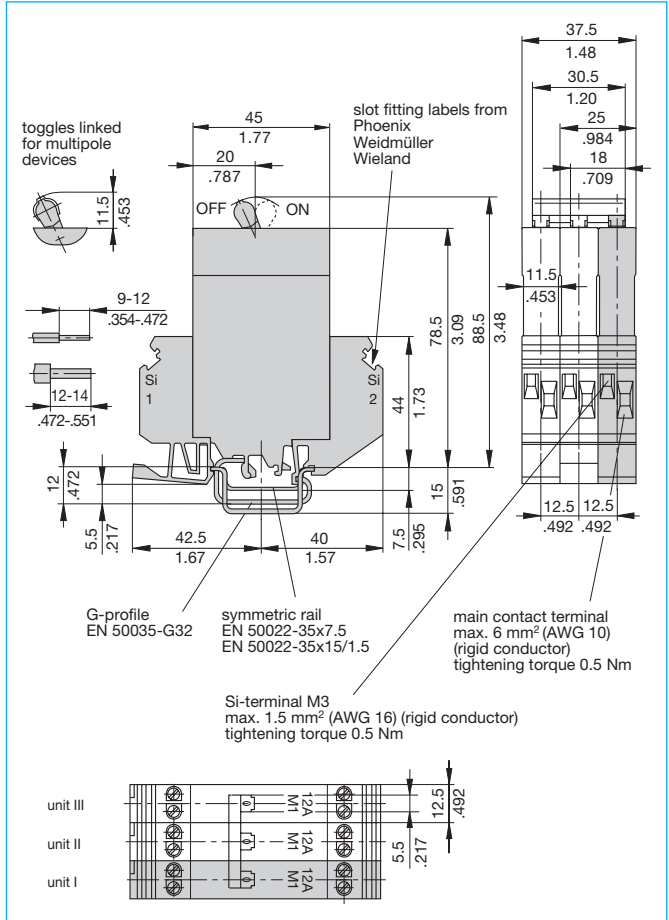

## Installation drawing

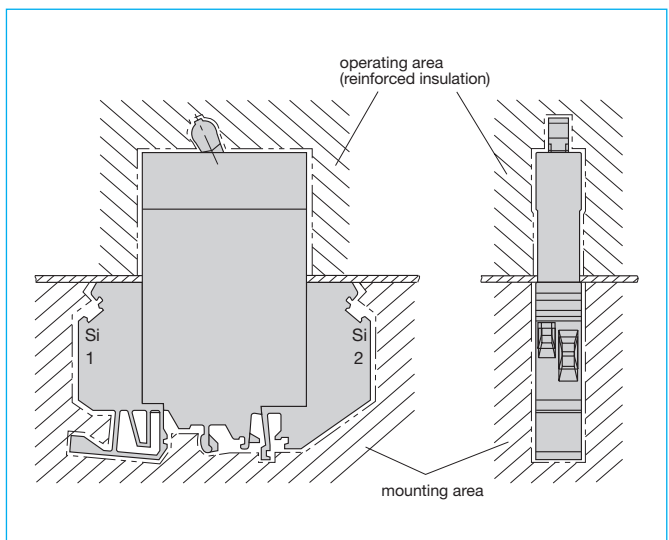

This is a metric design and millimeter dimensions take precedence ( $\frac{\text{mm}}{\text{inch}}$ )

## Internal connection diagrams

...-H131-...

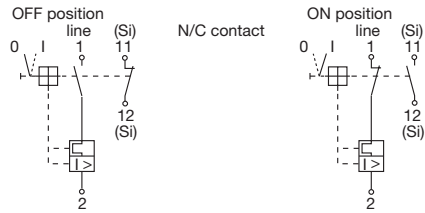

...-H121-...

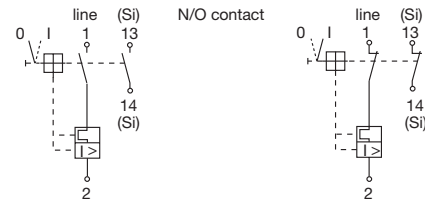

## Shock directions

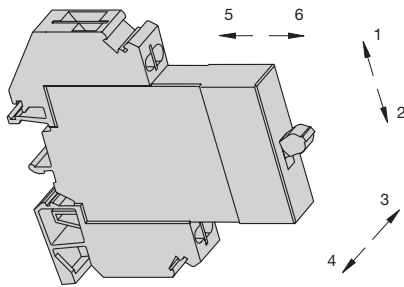

## Typical time/current characteristics

-F1 0.1...16 A

DC only

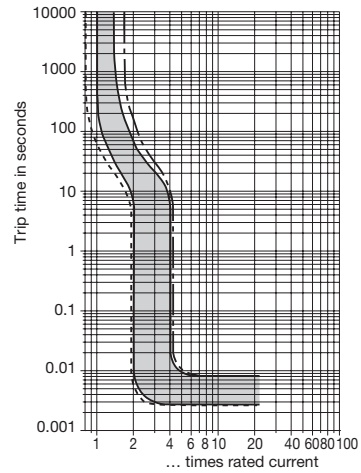

-F2 0.1...7.5 A

AC/ DC <sup>1)</sup>

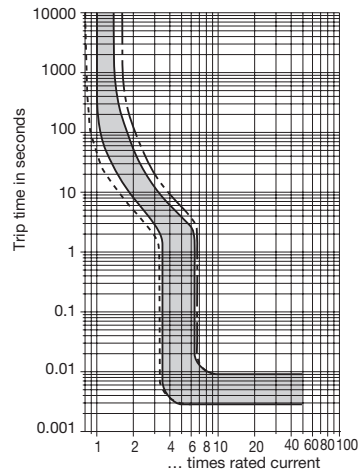

-F2 8...16 A

AC/ DC <sup>1)</sup>

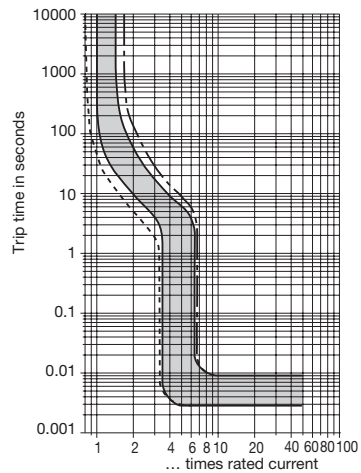

--- +60 °C / +140 °F    ——— +23 °C / +73.4 °F    - - - -30 °C / -22 °F

<sup>1)</sup> Magnetic tripping currents are increased by 30 % on DC supplies.

**Typical time/current characteristics**

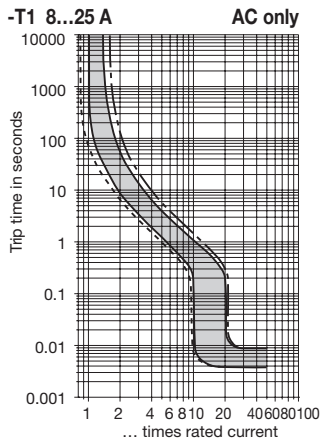
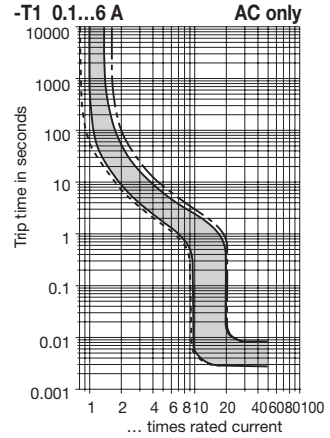
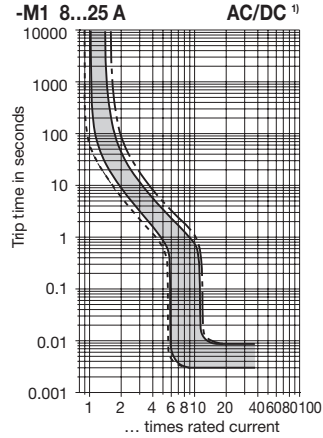
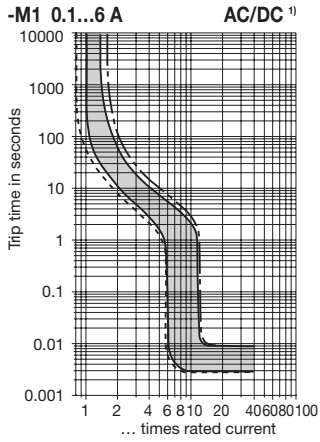

The time/current characteristic curve depends on the ambient temperature prevailing. In order to eliminate nuisance tripping, please multiply the circuit breaker current ratings by the derating factor shown below. See also section Technical information.

Ambient °F	-22	-4	+14	+32	+73.4	+86	+104	+122	+140
temp. °C	-30	-20	-10	0	+23	+30	+40	+50	+60
Derating factor	0.76	0.79	0.83	0.88	1	1.04	1.11	1.19	1.29

Multi pole devices: all poles symmetrically loaded. With single pole overload, thermal tripping will be at max.  $1.7 \times I_N$  with curves F1, F2 and M1.

<sup>1)</sup> Magnetic tripping currents are increased by 30 % on DC supplies (curves M1, T1).

3

## Accessories

### Connector bus links -K10

**X210 589 01/** 2.5 mm<sup>2</sup>, (AWG 14) (black) up to 20 A max. load  
**X210 589 02/** 1.5 mm<sup>2</sup>, (AWG 16) (brown) up to 13 A max. load

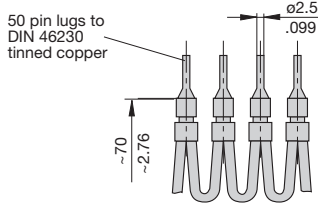

### Busbar 1-pole, 90°

**X 222 540 01**

The one metre long busbars can be cut to suitable lengths. Plug-on caps can be fitted on the ends to provide brush contact protection.

I<sub>max</sub> - busbar 100 A (40 °C)

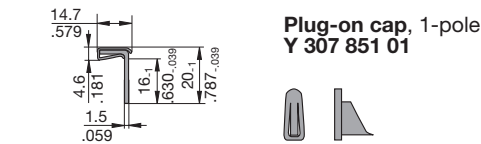
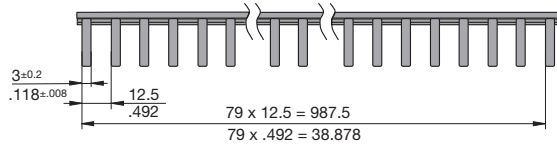

### Busbar 1-pole

**Y 308 498 01**

I<sub>max</sub> - busbar 100 A (40 °C)

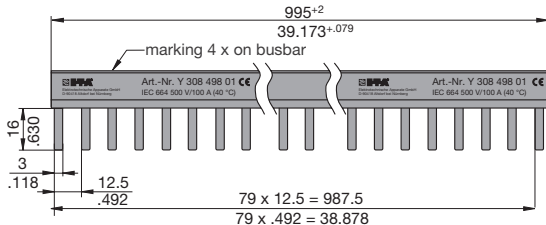

### Busbar 2-pole

**Y 308 499 01**

I<sub>max</sub> - busbar 100 A (40 °C)

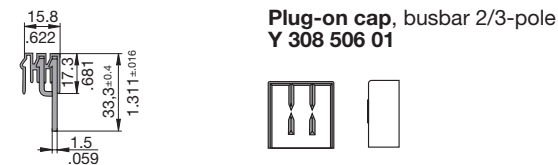
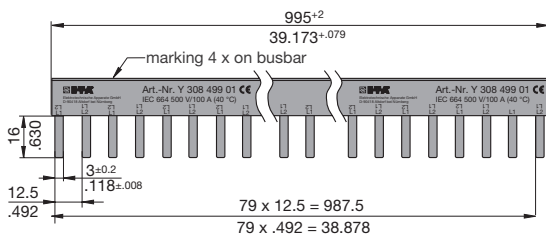

### Busbar 3-pole

**Y 308 500 01**

I<sub>max</sub> - busbar 100 A (40 °C)

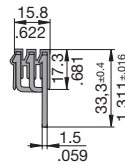
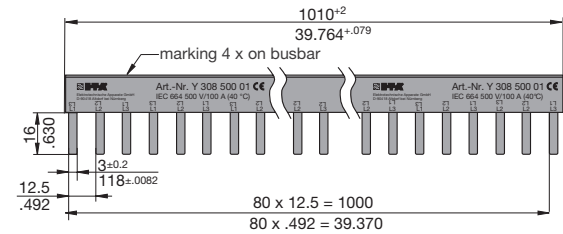

### Plug-on cap, busbar 2/3-pole

**Y 308 506 01**

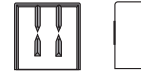

### Supply terminal

**Y 308 503 01**

I<sub>max</sub> 63 A with 1-pole busbar,

**50 A with multipole busbar**

Max. tightening torque of terminal screw 2 Nm

Max. cable cross section: 25 mm<sup>2</sup> / single strand

16 mm<sup>2</sup> / multistrand with wire end ferrule

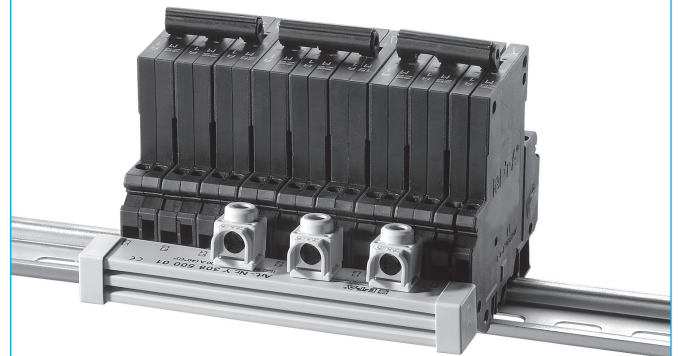
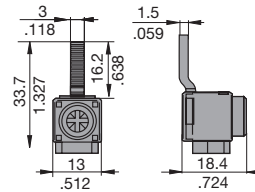

### Caution:

When using multipole busbars please leave at least one pole's width between two adjacent line entry terminals.

This is a metric design and millimeter dimensions take precedence (mm / inch)

All dimensions without tolerances are for reference only. In the interest of improved design, performance and cost effectiveness the right to make changes in these specifications without notice is reserved. Product markings may not be exactly as the ordering codes. Errors and omissions excepted.